

CAUTION



WET FLOOR



kaivac cleaning systems™

Complete Cleaning For Healthy Results™

Kaivac Tool Arrangement

Front Right View

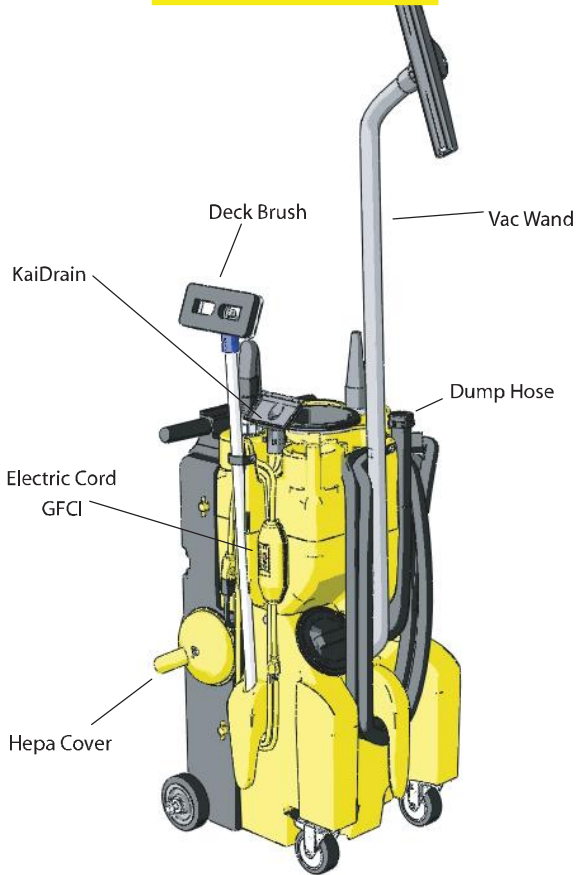

Rear Left View

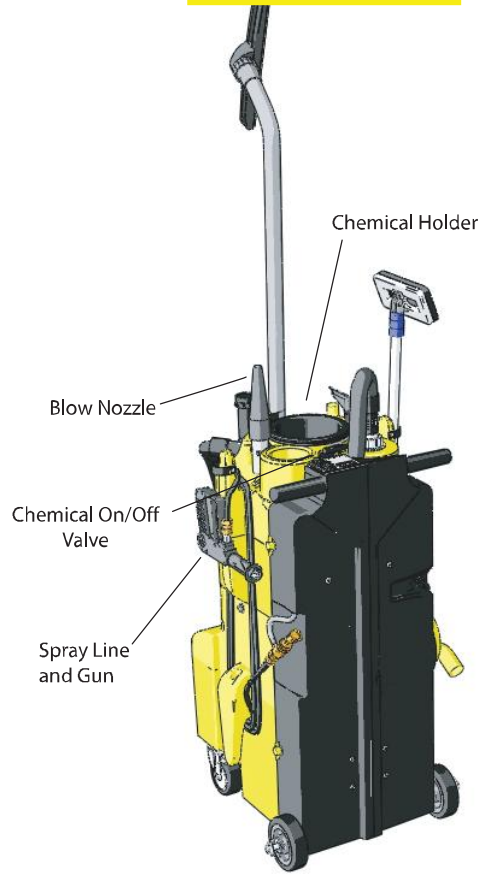

Overhead View

Front

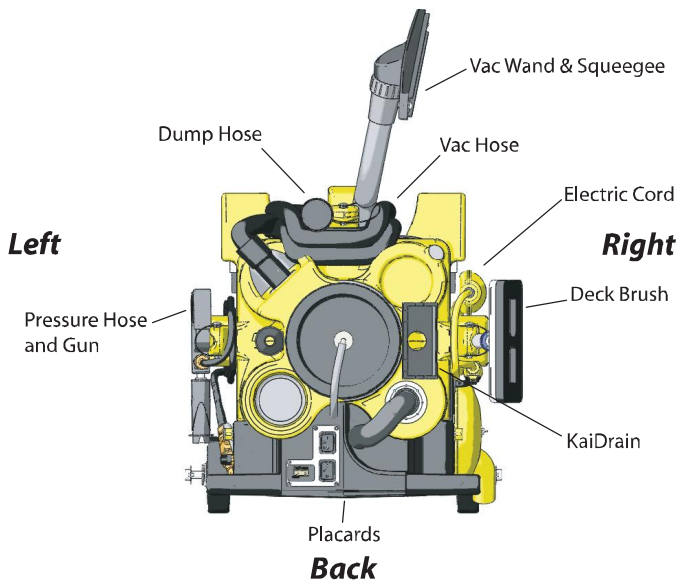

Bottom View

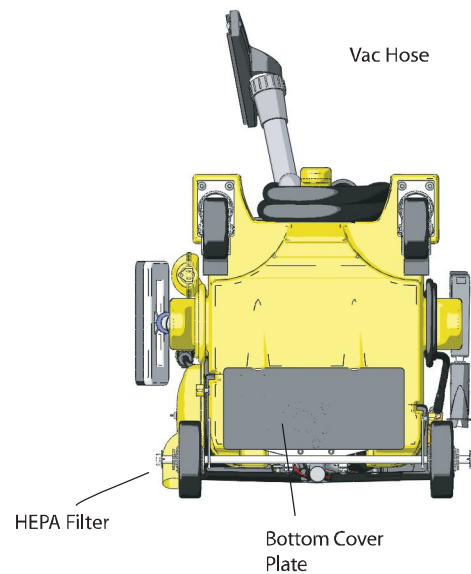

Kaivac Tips

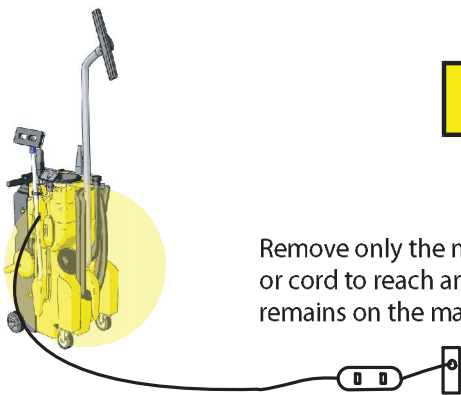

Remove only the needed hose or cord to reach area. Excess remains on the machine.



Dump into any toilet.

Fill Hose

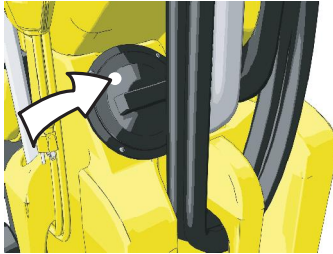

The Fill Hose is located in the Water Tank Lid assembly.

Wheel Chair



Spray proper cleaning solution on chair. Allow contact time. High pressure rinse to remove soils.



Blow dry with blower.

Blow Feature

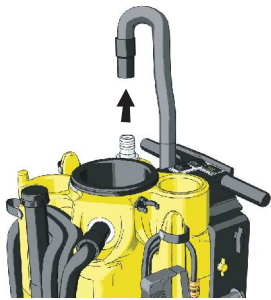

Disconnect vac inlet hose from top of machine.

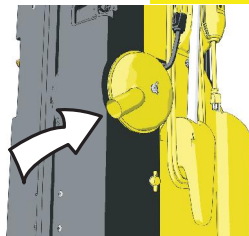

Attach the blow hose to outlet on HEPA filter cover.



Insert blow nozzle to blow-dust elevated areas.

Use blower for dusting and cleaning lockers and other areas.



Dry Vacuum Mode Operation (Optional)

Step 1

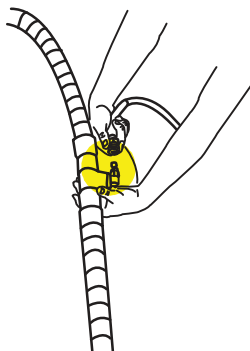

Remove spray gun from spray line. Connect spray line to optional Wet/Dry Vacuum Converter.

Step 2

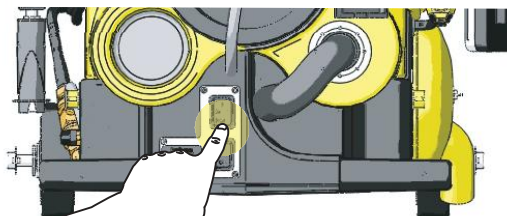

Empty vac tank and fill water tank. Turn on pump and vac motor.

Step 3



Begin cleaning with appropriate cleaning tool.

(A full tank should clean for approximately 60 minutes before vac tank fills. To continue, repeat steps 1 and 2.)

Kaivac Safety Tips



Incorrect way - could cause injury or damage to the machine.

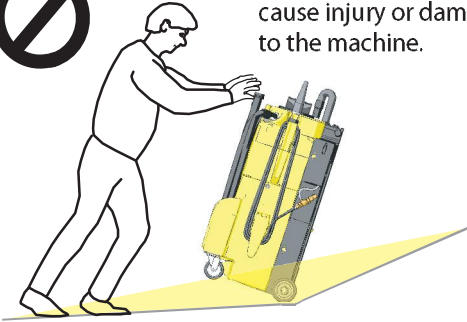

Proper way for steep inclines.

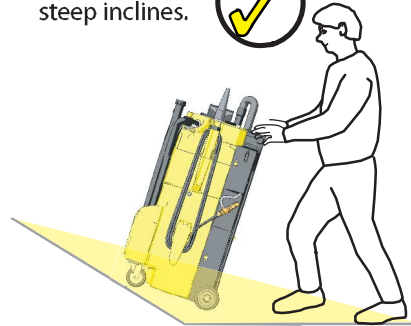

Never operate machine with worn hoses or cords. Inspect them daily.

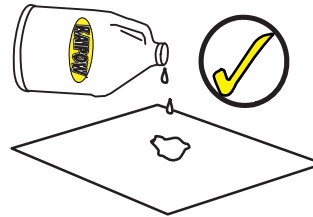
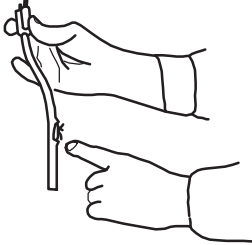

Test chemicals on all surfaces for compatibility.

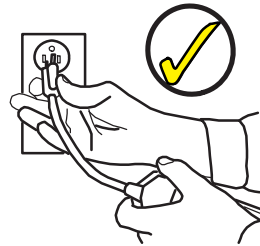

Remove by grasping plug. Never pull by cord.



Never spray gun towards electric outlets.

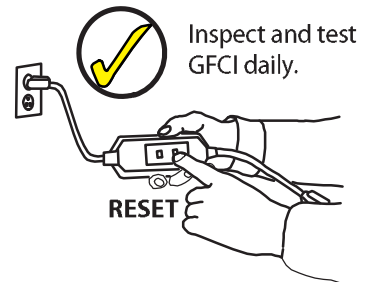

Inspect and test GFCI daily.



Never spray gun at people.

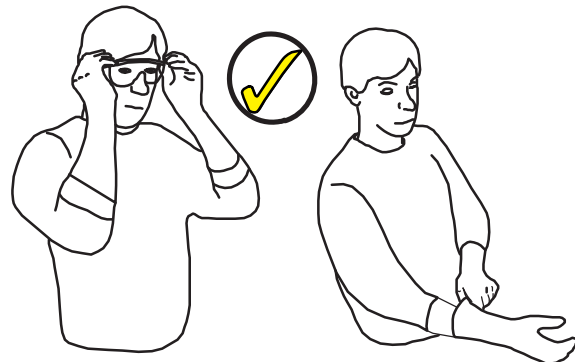
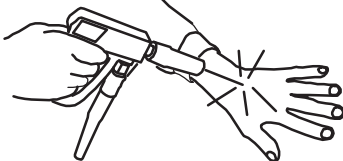

Always wear safety eyewear and gloves.

Kaivac Diluting Chemicals

Unlike manual cleaning methods, the No-Touch Cleaning process uses color-coded metering tips to accurately control chemical dilution.

The dilution level is determined by:

1. Soil conditions of the area or surface being cleaned

- Light duty cleaning requires fewer ounces per gallon of cleaning chemical than heavy duty cleaning.
- From our experience, daily cleaning requires a lighter dilution than initial or periodic cleaning.
- Initial cleaning or heavily soiled surfaces may need to be “shock” cleaned to loosen stubborn soil.
- Always try to use lowest possible dilution level to achieve proper cleaning results.

2. The pressure of the pump, measured in pounds per square inch (p.s.i.)

- To determine the pressure rating (p.s.i.) of your machine’s pump refer to its white serial plate. (FIG. 1)
- The first four numbers of the serial number will determine type and p.s.i. of unit.
EXAMPLE: 12**20** is a 200 psi and 12**50** is a 500 psi.
- If you need assistance, call Customer Service at 1-800-287-1136 with your serial number (on serial plate) for your pump’s pressure.

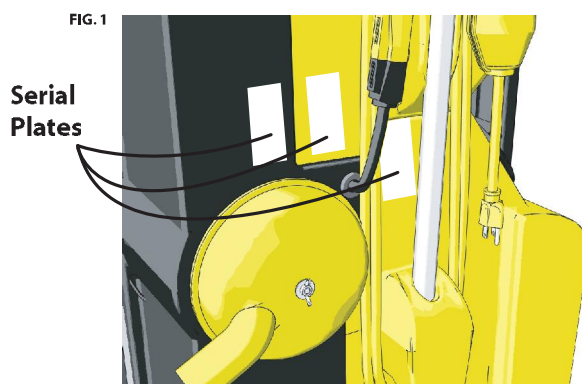

Metering Tip Chart

(Cold Water Only)

200 p.s.i.		500 p.s.i.	
TIP	Oz. per Gallon	TIP	Oz. per Gallon
• Black	1.25	• Black	2
• Aqua	3.00	• Aqua	4
• Orange	4.75	• Orange	5
• Tan	9.50	• Tan	10
• None	35	• None	40

Kaivac Priming Procedure

*On rare occasions, the pump may not prime properly.
In such a case, follow these steps.*

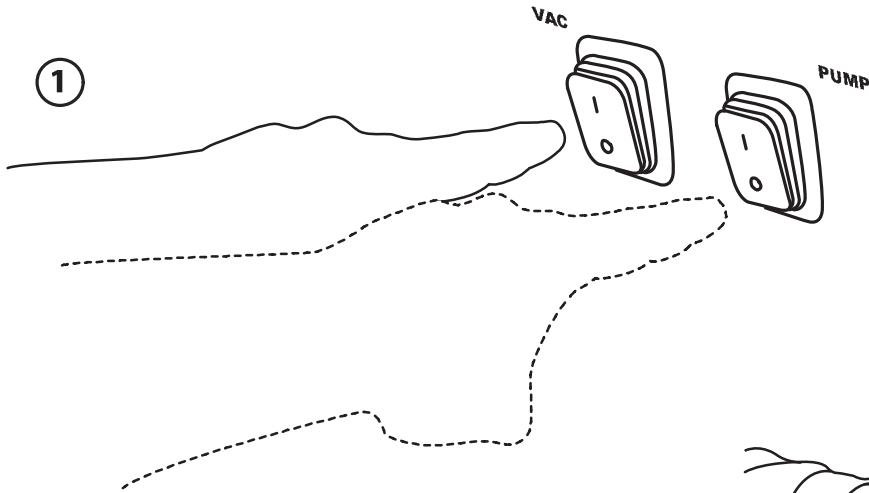

Step 1. Fill water tank with fresh water and turn on vac and pump motors.

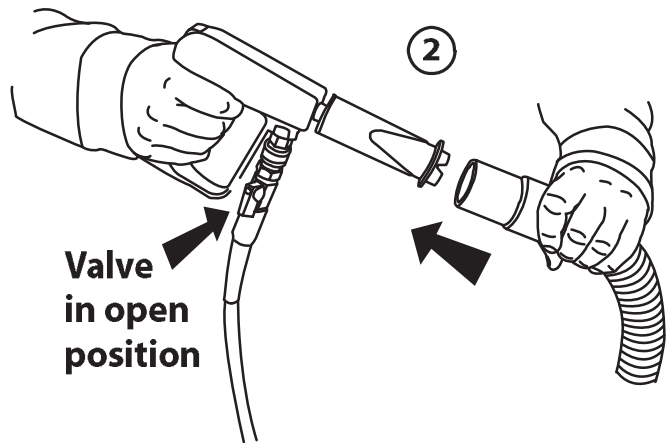

Step 2. Press vacuum hose cuff against spray nozzle of gun tightly.

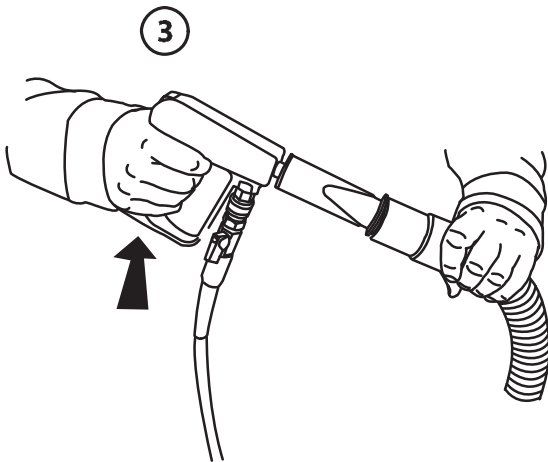

Step 3. Squeeze trigger on gun to allow vacuum suction to prime pump. When the pump has been primed, the pump motor sound should deepen.

Step 4. Release trigger and remove vac hose from nozzle. To prevent water from dripping out of vac hose, continue to run vac for an additional 8 seconds. Priming is now complete.

S.I.M.P.L.E.

No-Touch Cleaning Process

S et-up



I nject chemicals

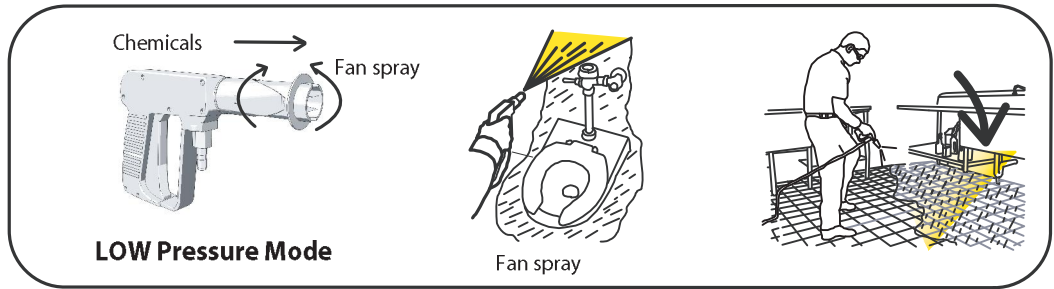

M anual brush (optional)

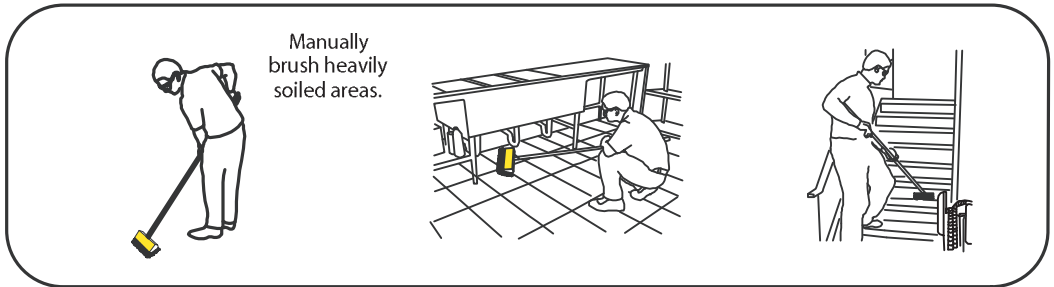

P ressure wash and rinse

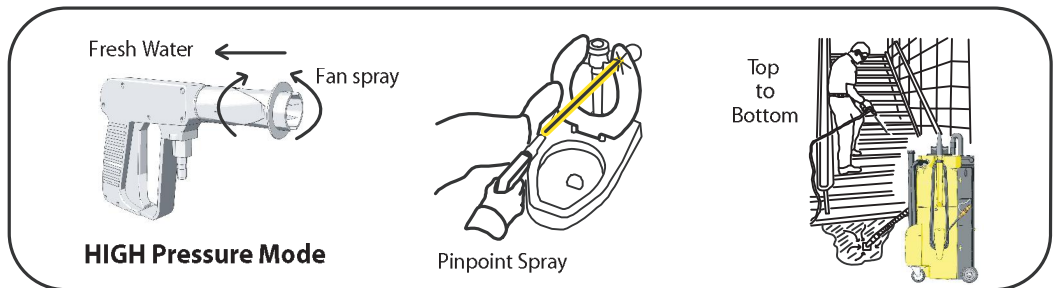

L oop spray line

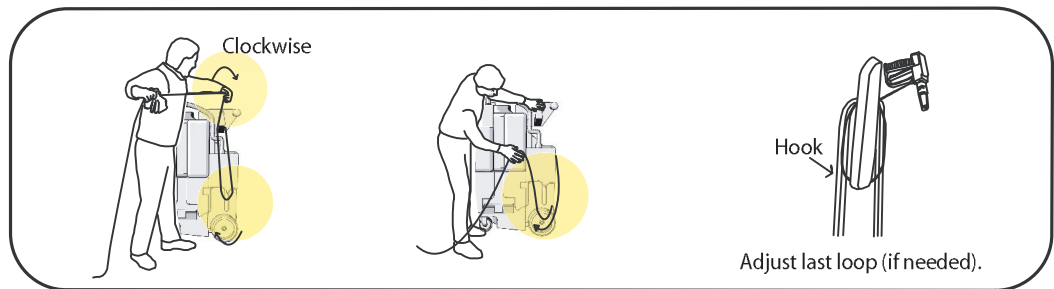

E xtract and dry

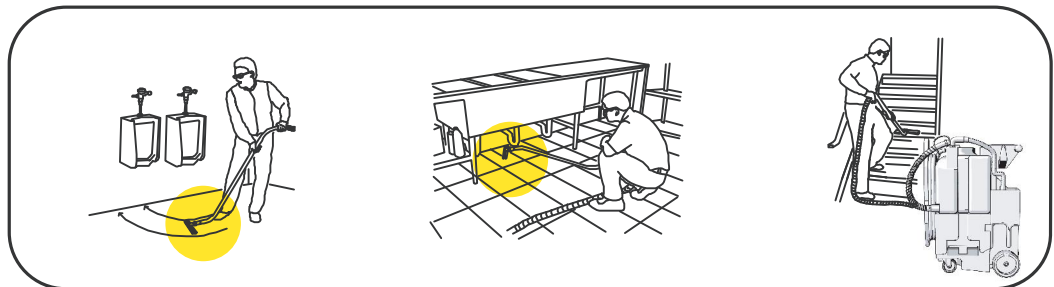

Kaivac No-Touch Restroom Cleaning

Suggested chemical: KaiBloey™

- 1**

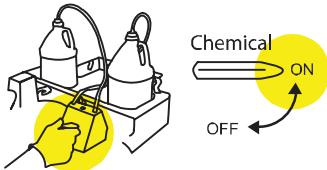

Turn chemical valve on. Check tank levels. Optional: Dust with KaiHose
- 2**

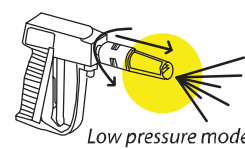

Adjust spray gun to chemical injection. Pull nozzle out and rotate for fan pattern.
- 3**

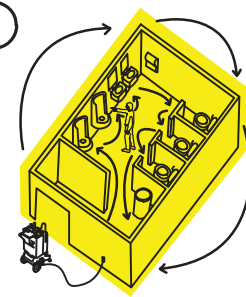

(Pre-test chemicals on all surfaces before using.) Inject chemicals on fixtures and soiled surfaces. Start at the nearest fixture, traveling in a circular pattern.
- 4**

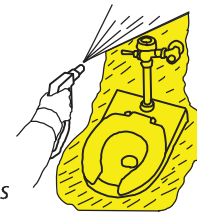

7 sec. Chemical Injection
- 5**



3 sec. Chemical Injection

Apply cleaning solution to fixtures.
- 6**

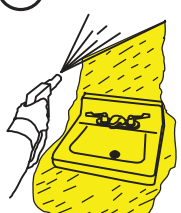

2 sec. Chemical Injection
- 7**

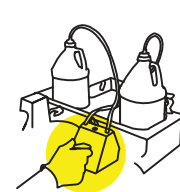

Turn chemical valve off.
- 8**

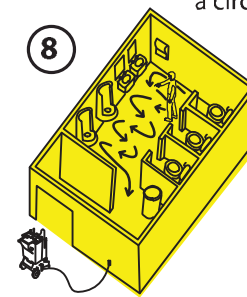

Flush chemical from spray line onto floor. Optional: Manually brush heavily soiled areas.
- 9**



High pressure mode

Push nozzle in and rotate to a pinpoint pattern. Adjust spray gun for high pressure wash and rinse.
- 10**

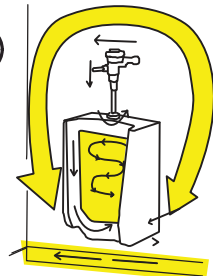

Pressure wash fixtures in a top-to-bottom pattern.

15 sec. High pressure rinse
- 11**

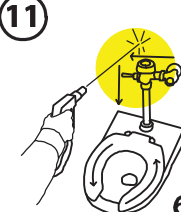

6 sec.

Pinpoint rinse plumbing and seat top.
- 12**

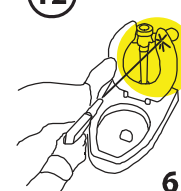

6 sec.

Lift seat. Rinse hinges and seat bottom.
- 13**



Rim Shot

4 sec.

Place nozzle under rim and rotate.
- 14**



Slam Dunk

4 sec.

Spray into bowl.
- 15**

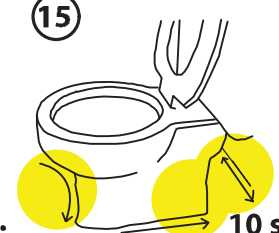

10 sec.

Spray bottom and base.

Toilet cleaning time: 30 sec. (for high pressure rinse).
- 16**

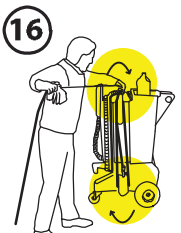

Loop and dry hose onto wraps.
- 17**

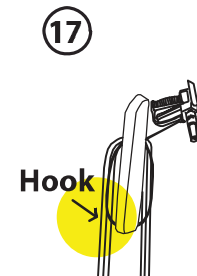

Hook

Adjust last loops.
- 18**

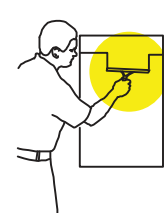

Squeegee mirrors and flat surfaces.
- 19**



Wet vac restroom floor from front to rear. Load paper and supplies, then examine.
- 20**

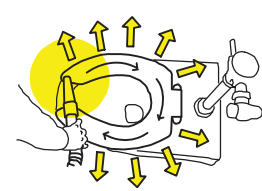

Optional

Blow dry flush handles and toilet seat tops for immediate use.

Kaivac Hallway Cleaning

Method of Use

I. Apply cleaning solution

1. Unwrap the spray gun and pressure hose. Leave 2 loops wrapped on the No-Touch Cleaning machine.
2. Using the spray gun, apply a wide spray pattern of cleaning solution to the floor in a serpentine manner. (1 gallon covers approximately 800 ft.)
3. For daily cleaning of waxed floors, it is recommended that you use a neutral (pH7) cleaning solution, such as KaiO™ from Kaivac.

II. Vac off

1. Connect the KaiAuto™ wide area squeegee head to the vac wand and hose.
2. Start vacuuming to the right of, and away from, the No-Touch Cleaning machine, heading along the wall.
3. Proceed along the wall until you reach the limit of the hose length.
4. Turn to the left 180° heading back toward the machine with a 2" overlap of the previous pass.
5. Swerve KaiAuto towards the wall just as you pass the No-Touch Cleaning machine (now vacuuming the wall on the left side of the machine) and continue down the hall.
6. At the end of the hose, make a 180° right turn heading back towards the unit with a 2" overlap of the previous pass.
7. Continue with this method until you reach the far wall away from the cleaning machine.

(Please see the training video for more information.)

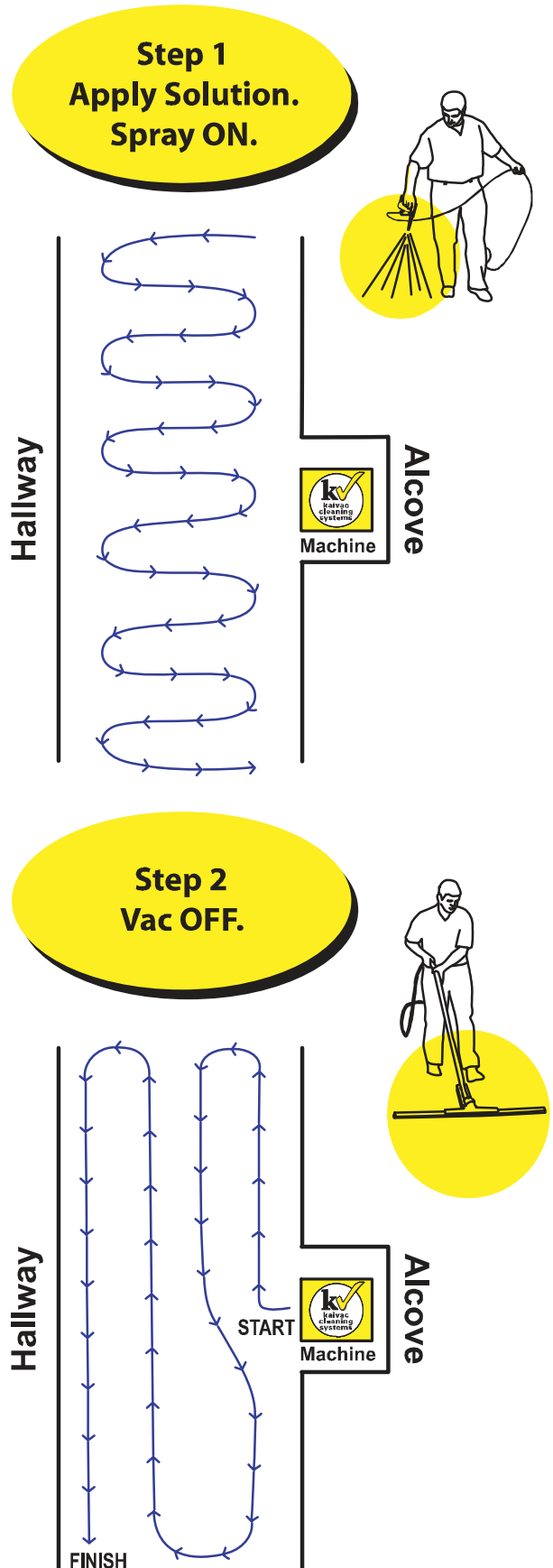

Kaivac Stairwell Cleaning

- ① Insert blow nozzle to blow-dust elevated areas.



- ② Position machine at bottom of stairs. Dust cobwebs from high and hard to reach areas using KaiBlower and squeegee wand.

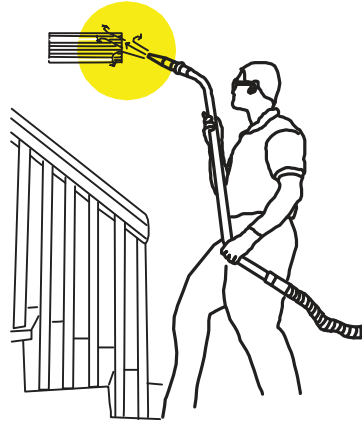

- ③ Position KaiDrain at bottom of steps to suction excess moisture.

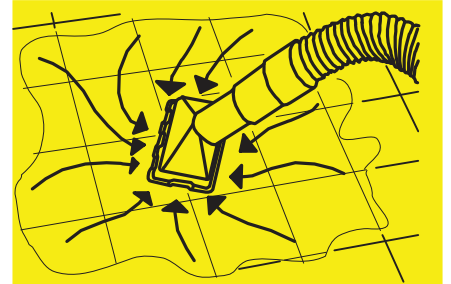

KaiDrain is an instant drain for use when puddling occurs.

- ④ Inject chemicals and apply to walls and stairs.

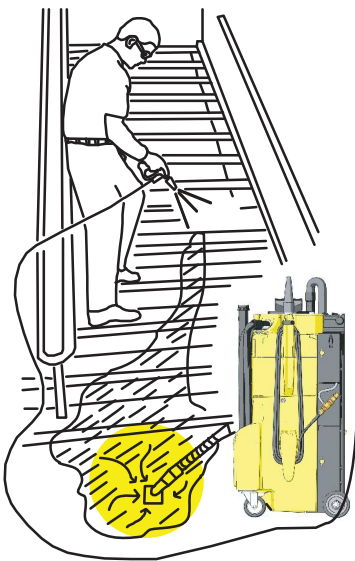

- ⑤ Wash and rinse with high pressure spray to remove soils. In case of heavy soils, use brush on walls and stairs.

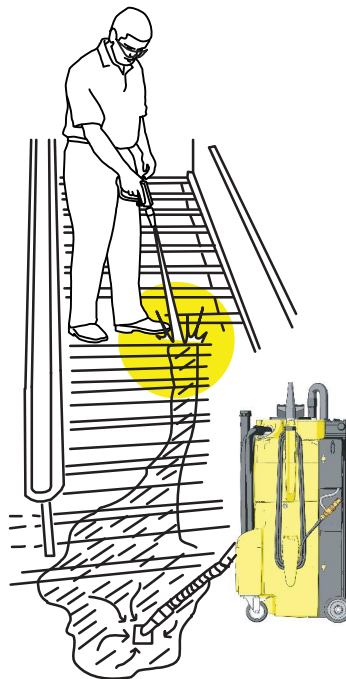

- ⑥ The floor squeegee tool sucks away soils and solution, leaving stairwells sparkling clean. Soils are contained in the machine for later disposal.

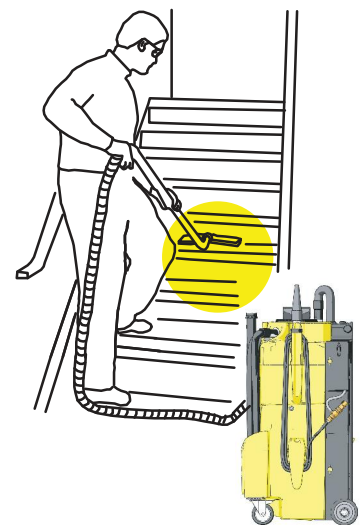

Kaivac Classroom Cleaning

Front Entrance Classroom

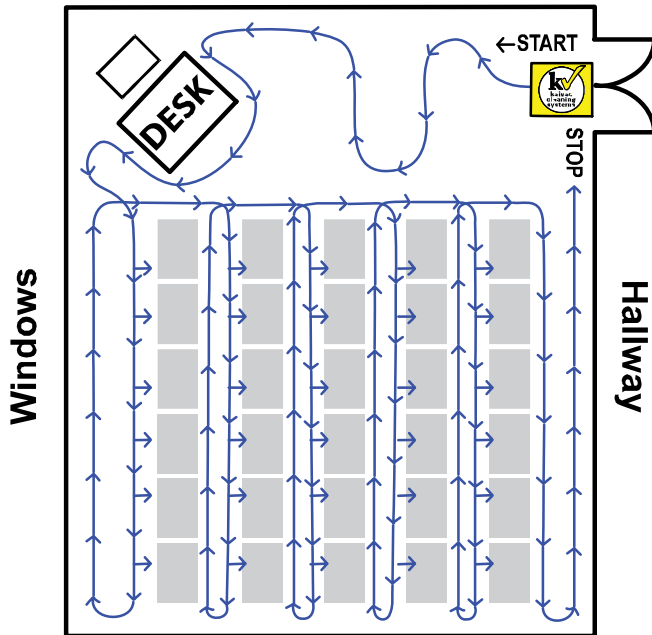

Park unit at entrance of classroom.

Cleaning Procedure

I. Daily

1. Setup No-Touch Cleaning machine for dry vacuuming.
 - Attach Wet/Dry Converter and dry vacuum head.
 - Park unit at entrance (see illustration for location and vacuum flow pattern).
 - Plug unit into outlet.
2. Close and lock all windows.
3. Empty pencil sharpeners.
4. Pick up large debris from floor (pencils, papers, etc.).
5. Empty trash can.
6. Dry vacuum as shown in illustration. Clean aisle space directly in front of you. Then, clean under chair next to you. Repeat until row is finished.
7. Spot clean floor with spray bottle and flat microfiber mop head.

II. Weekly

1. Dry vacuum horizontal surfaces (teacher's desk, window sills, cabinets, etc.).
2. Dry vacuum computer screens.
3. Spot clean walls, desktops and windows.
4. Clean inside trash can with spray gun and KaiDrain (instant drain).
5. Clean chalkboard and tray.

For oversized rear entrance classroom, park unit at front of classroom to start.

(Please refer to training video for more information.)

Rear Entrance Classroom

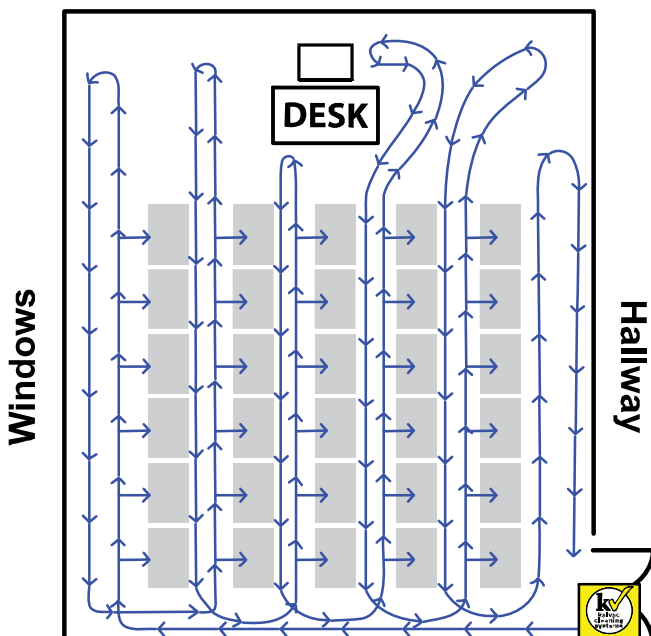

Kaivac Kitchen Cleaning

Suggested chemical: KaiPow™

1

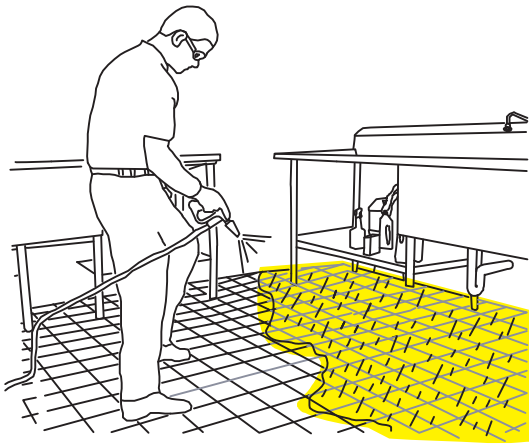

Inject chemicals on soiled surfaces and floor.

2



Manually brush floor in heavily soiled areas.

3

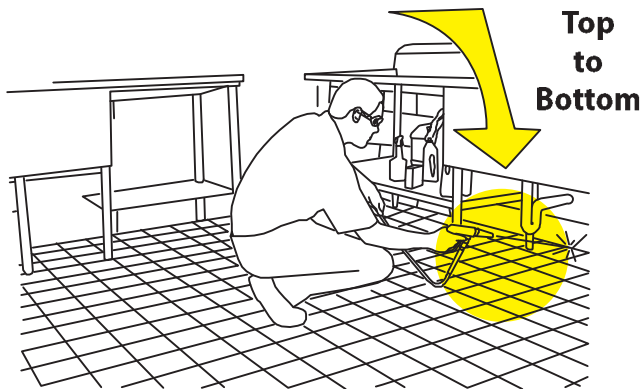

Pinpoint spray works great removing soils in corners and around base boards.

4

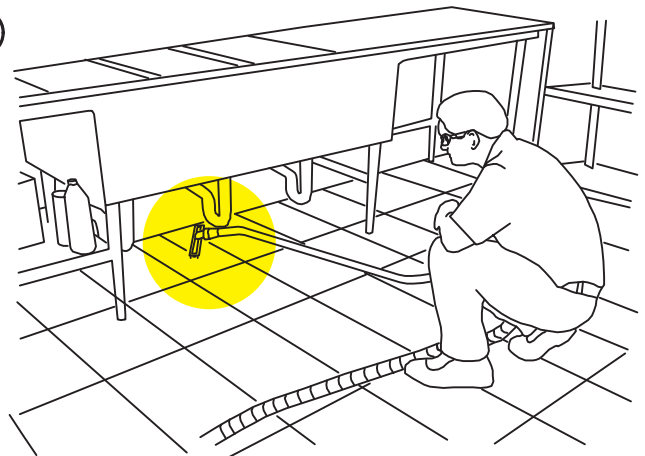

Vacuum soiled liquid from floor. Lay wand flat to maneuver under equipment and fixtures.

Kaivac KaiGrouter

Connect spray line and vac hose to KaiGrouter.

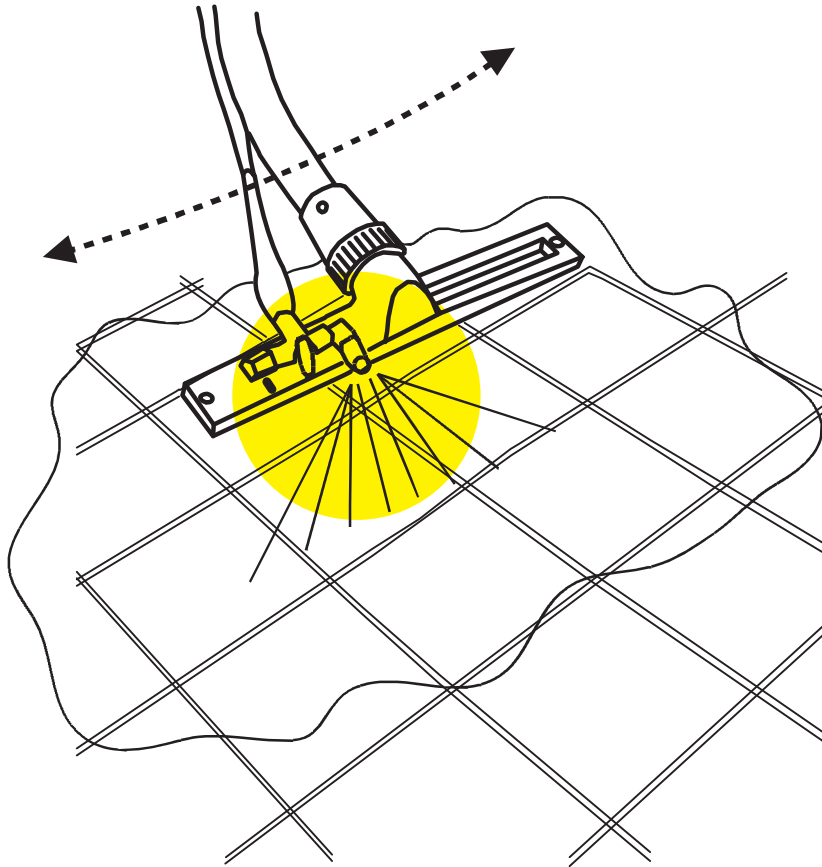

- ① Turn valve to fan spray to apply chemical. Lift head off floor and move over floor spraying chemicals.

- ② Turn valve to high pressure setting, line up yellow guide line with grout line, pull trigger and move along grout line.

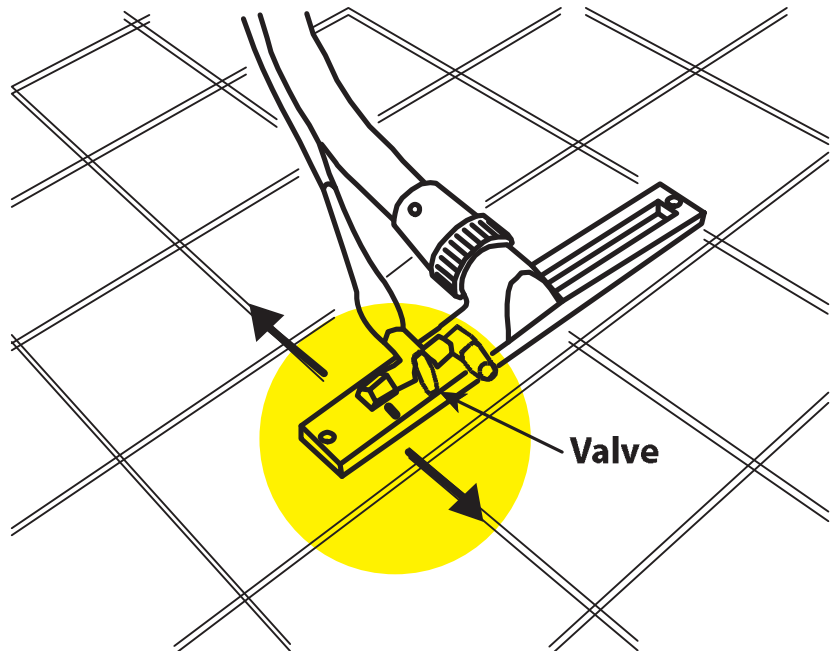

Kaivac General Maintenance

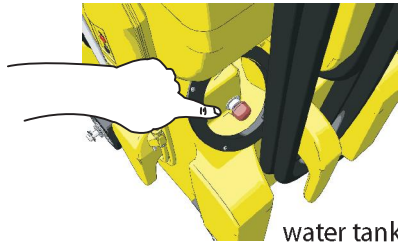

water tank

Inspect filters for dirt. If found, remove cover, clean filter screen and reinstall.

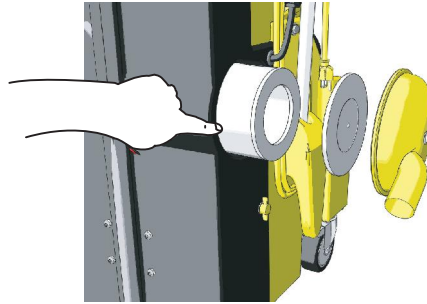

Inspect muffler for soils. If found, remove and replace.

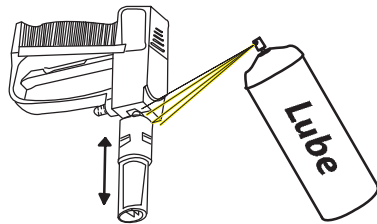

(Weekly) Lubricate nozzle with penetration oil. Nozzle must move freely forward and backwards.

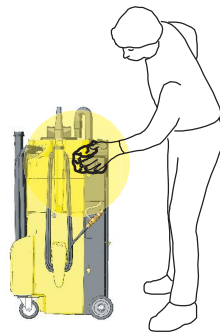

Wipe entire unit clean with an all purpose cleaner. (Do not pressure wash machine.)

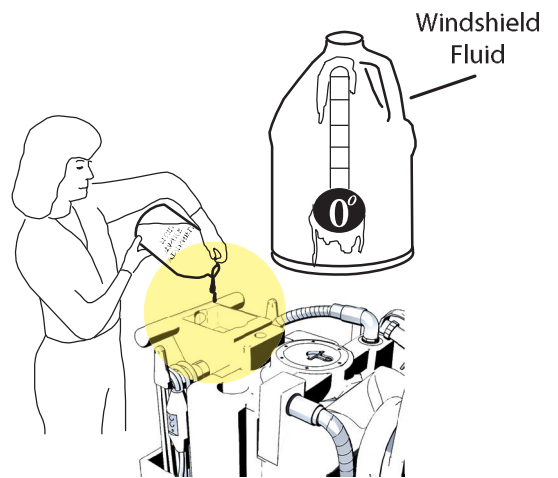

Winterize system for outdoor storage or transport in sub freezing temperatures. Remove all water from tank, add 1/2 gallon windshield washer fluid. Run pump and spray until fluid is discharged from gun.

Unscrew locking collar to remove tools.

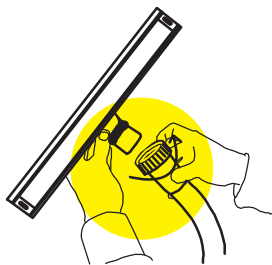

For floor squeegee, ensure brass ring is located in groove.

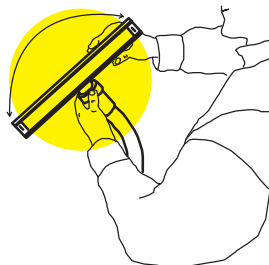

When collar is snug, floor squeegee should rotate freely.

Floor Squeegee

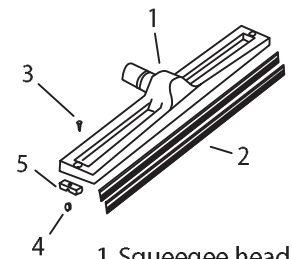
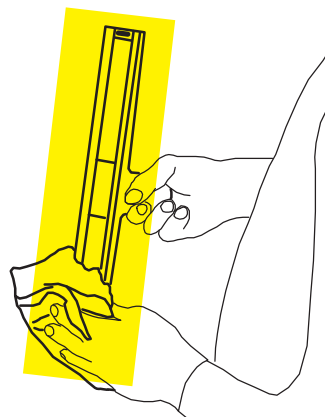

1. Squeegee head
2. Blades
3. Screw
4. Wheel
5. Wheel Holder

Wipe squeegee blades with cloth. Inspect tool for worn wheels and blades. Replace as needed.

Kaivac Tank and Hose Cleaning

1. Unwrap vac hose and lay it on floor.
2. Lower end of vac hose to surface of water in fresh water tank, gulping both air and water. This action flushes soils from line and quickly empties fresh water tank.

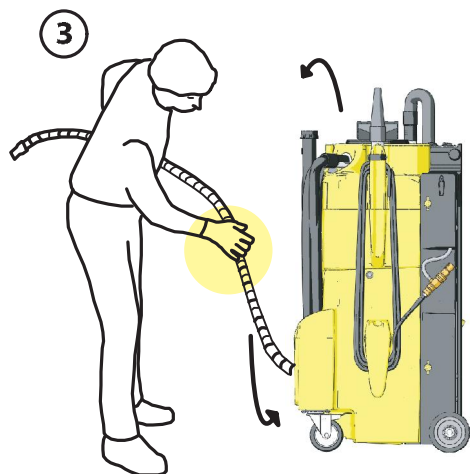
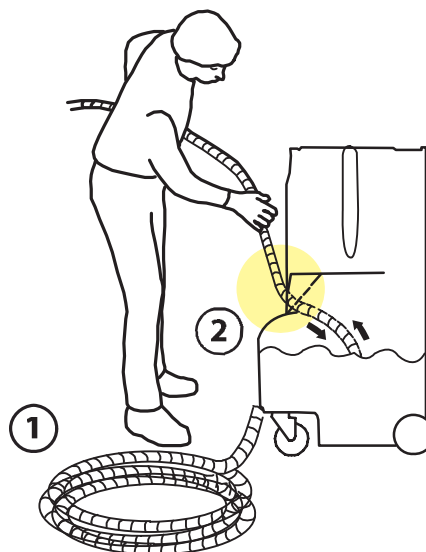

3. Vac hose can now be wrapped onto machine. Leave vac motor running while wrapping to avoid water dripping from end of hose. To completely dry hose, leave vac motor running for about 3 minutes.

4. To clean vacuum recovery tank, spray inside of vac tank with clean water with dump hose positioned by floor drain. Move hose in a circular pattern to ensure tank walls and float shutoff are rinsed.

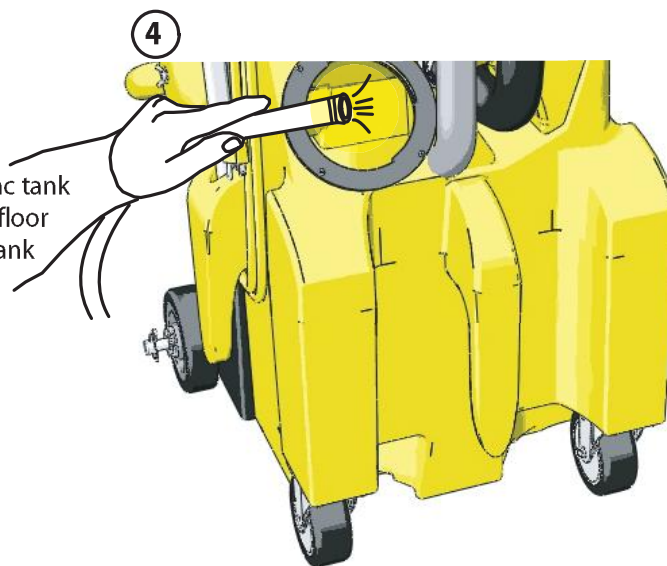

Kaivac Fill Hose Instructions

1

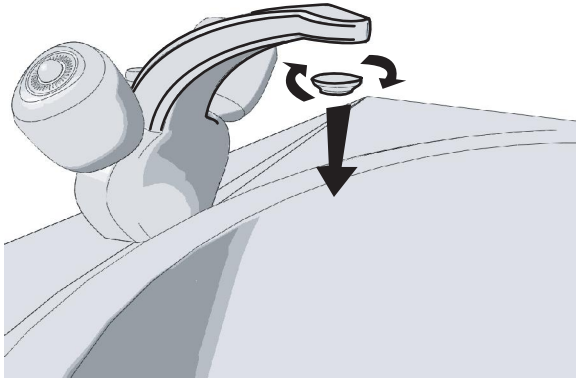

Remove filter insert from faucet head.

2

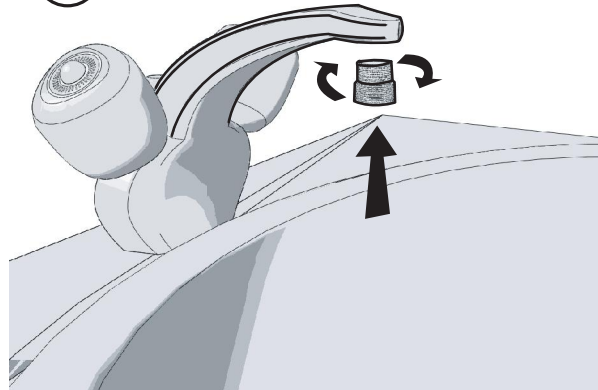

Replace with fill the supplied hose adapter.

3

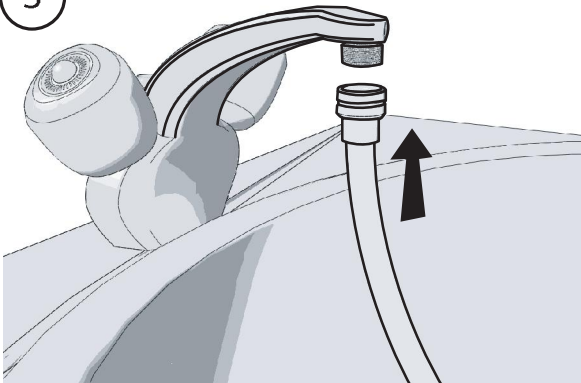

Attach the fill hose firmly to the adapter.

5

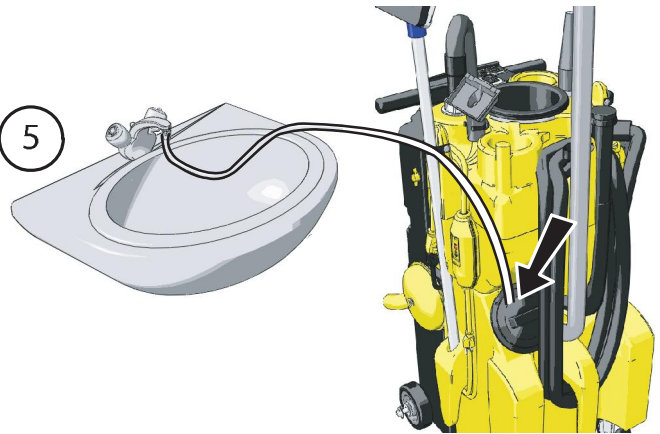

Place the fill hose in the appropriate fill location on your machine.

6

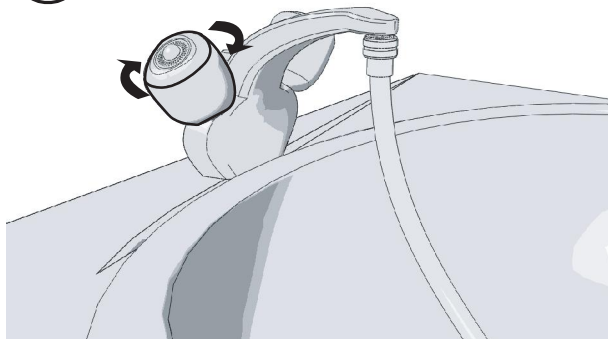

Slowly turn the cold water valve or knob on to start filling your machine.